

Intelligent DC UPS Module

12V/9~36V DC Input, 12V DC Output Uninterruptible Power Supply Module with Diagnostics

- VESA 75 or VESA 100 mounting
- 9-36V input through terminal or power jack, or 12V through power jack only
- Battery status and charge monitoring utility. Remote network management capabilities

Features

- 60W (5A @ 12V) or 100W (8.3A @ 12V) output
- 28Wh or 56Wh, for more than 140 minutes operation time (dependent on panel PC power requirements)
- Rugged metal enclosure for standard VESA 75/100 mounting
- Web-based, remote network management, no software installation required
- Local PC-based monitoring software for input detection and battery status monitoring
- Auto shut down when battery low
- Remote DC output ON/OFF switch for external switch installation
- Provides stable power to the PC during line sags and spikes and absorbs power surges and transients, protecting expensive equipment

Model Name	AUPS-A10-R10 AUPS-A20-R10	AUPS-B10-R10 AUPS-B20-R10
Input Power	AUPS-A10-R10 12V AUPS-A20-R10 9~36V	AUPS-B10-R10 12V AUPS-B20-R10 9~36V
Dimensions	150 x 95 x 34 mm	170 x 150 x 34 mm
Battery Capacity	28 Wh (Watt/H our)	56 Wh (Watt/Hour)
Output Power	60W (5A@12V)	100W (8.3A@12V)
VESA Support	75x75 mm	75 x 75 mm 100 x 100 mm



AUPS-A10
VESA 75, 12V DC Input 12V
DC, 5A, 60W Output



AUPS-A20
VESA 75, 9V~36V DC Input
12V DC, 5A, 60W Output



AUPS-B10
VESA 75/100, 12V DC Input
12V DC, 8.3A, 100W Output



AUPS-B20
VESA 75/100, 9V~36V DC
Input 12V DC, 8.3A, 100W
Output

Intelligent UPS Module

High Energy Density / Lightweight / Compact DC to DC UPS & Power Module

Protect your panel PC from electrical damage and greatly reduce the risk of losing data.

The UPS module serves as temporary power during a short break in power and allows a safe system shutdown for longer periods of power loss.

1. DC 9V~36V input by terminal block (Only AUPS-A20 / AUPS-B20)

**2. (1) Only 12V input by DC jack (AUPS-A10 / AUPS-B10)
(2) Wide 9V~36V input by DC jack (AUPS-A20 / AUPS-B20)**

A. Dual Power Input Connector

B. Battery Status USB Console Port

**C. DC Power button
DC Remote Power button**

D. Networking UPS Management Port by RJ-45 Ethernet

LED Signal Table			
	LED 1	LED 2	LED 3
Color	Green	Yellow	Orange
Function	Power Input	Charger Status	Battery Status
Dark	DC Power Out	Discharging	Battery Full
Light	DC Power In	Charging	Battery Low
Blinking			

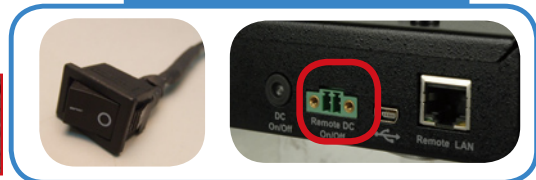
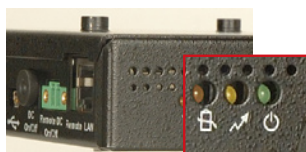

1
Automation
Panel
Solutions

2
All-in-One
Touch POS

3
Digital
Signage

4
Video Wall
Controller

5
RISC-based
Solutions

6
PACsmate
Medical

7
Optional
Peripherals

AUPS Module Specifications

Model Name		AUPS-A10	AUPS-A20	AUPS-B10	AUPS-B20
VESA Type		VESA 75	VESA 75	VESA 75 and 100	VESA 75 and 100
Input Data	Input voltage Uniated/range	DC +12V	DC +9V~+36V	DC +12V	DC +9V~+36V
	Input current rated	1. Adapter is 12V-6A (Load is 60W) 2. Battery is 6V-12A (Load is 60W)		1. Adapter is 12V-9A (Load is 100W) 2. Battery is 12V-9A (Load is 100W)	
	Standby power consumption	0.3A (0.2A if Network Management disabled)			
	Operation with charging current	500mA			
	Operation with charging power consumption	6W		10W	
Charging time with system ON/OFF		8hrs / 2hrs (Battery empty)			
Output Data	Output voltage for normal operation	DC +12V +/-5%			
	Output voltage for battery operation, approx.	6-8.4V DC6 V (exhaustive discharge protection)		12~16.8V DC12 V (exhaustive discharge protection)	
	output current	0A~5A		0A~8.3A	
Efficiency(nominal operation)/power lossat Vin=12V, Iout=80% of full loading		89%	93%	95%	94%
Protection	short-circuit protection	Yes			
	Exhaustive discharge protection	1.Battery low is 10% of Battery capacity 2.Shutdown 5% of Battery capacity (Default) 3.The end of Battery discharge voltage is 6V			
	EMC / Safety certification	UL, TUV, CE, FCC			
Monitoring	Ethernet interface	Web-based, specification 10/100Mbps with RJ-45 connection, Cat. 5 cable			
	USB interface	PC-capable, specification 2.0 with full speed, i.e. 2 Mbit/s. Standard 4-core shielded cable, USB Series "mini B" connector to DC-UPS			
Physical	Dimensions	152mm(L) * 96mm(W)*28mm(H)		174mm(L) * 147mm(W)*35mm(H)	
	Weight	1.2 kg		1.8 kg	
LED Indicator	Green	DC power input			
	Yellow	Battery charging			
	Orange	Bettery discharging			
Environment	Operating Tem.	0°C~40°C			
	Storage Tem.	-20°C~50°C			

Note1: Suggest to connect DC input constantly. Battery will be drained after 14 hours.

Note2: System power consumption + AUPS charging power consumption = Total watts of power source

Battery Module Specifications

Model Name		AUPS-A10	AUPS-A20	AUPS-B10	AUPS-B20
Battery Model Name		BAT-LI-2S2P3800			BAT-LI-4S2P3800
Battery	battery type	Li-Ion 2S2P 7.4V			Li-Ion 4S2P 14.8V
	Battery capacity	7.4V 3800 mAh			14.8V, 3800 mAh
	Maximum charge voltage	8.4V			16.8V
	The end of discharging voltage	5.6V			11.2V
	Suggestive charging current (Max.)	2A			2A
	System continuous discharging current(Max)	7.6A			7.6A
	The end of charge condition	250mA / 1Min			200mA / 1Min
	Discharge protection	Under voltage protection / Over current protection			
	Charge protection	Over voltage protection / Over current protection			
	Ambient temp	0°C~40°C			0°C~40°C
	Storage Tem	-20°C~60°C			-20°C~60°C
	Self-discharge rate	340uA~440uA			
	Dimensions	139mm(L) * 47mm(W)*26mm(H)		165mm(L) * 76mm(W)*26mm(H)	
	Weight	236g		450g	
	Cycle life	300 charge / discharge cycles			
Backup	60W / 10Min		100W / 10Min		
Safety class	CE, UL, TUV				

Note: Suggest to replace Battery Module every 2 years.

Selection table for UPS modules and main buffering time

AFOLUX PPC	AUPS-A10	AUPS-A20	AUPS-B10	AUPS-B20
Under 50W solution				
AFL-057-LX (15W~20W)	145min	145min	290min	290min
AFL-07A-N270 (20W~25W)	100min	100min	200min	200min
AFL-08AH-N270 (25W~30W)	70min	70min	140min	140min
AFL-10A-N270 (25~30W)	70min	70min	140min	140min
AFL-10A-9103 (40W~45W)	50min	50min	100min	100min
AFL-10A-LX (25W~30W)	70min	70min	140min	140min
AFL-12A-LX (25W~30W)	70min	70min	140min	140min
AFL-12B-CX2 (38W~42W)	50min	50min	100min	100min
AFL-12A-N270 (25W~30W)	70min	70min	140min	140min
AFL-12B-9103 (45W~48W)	45min	45min	90min	90min
50W ~ 100W solution				
AFL-15B-915-CM370 (58W~63W)	-	-	35min	35min
AFL-15C-9652-T7500 (65W~70W)	-	-	30min	30min
AFL-17B-915-CM370 (75W~80W)	-	-	25min	25min
AFL-17C-9652-T7500 (85W~90W)	-	-	20min	20min
AFL-19B-915-CM370 (75W~80W)	-	-	25min	25min
AFL-19C-9652-T7500 (85W~90W)	-	-	20min	20min

Note: The backup time could be varied on different models or operating temperature.



BAT-LI-2S2P3800

BAT-LI-4S2P3800

1
Automation
Panel
Solutions

2
All-in-One
Touch POS

3
Digital
Signage

4
Video Wall
Controller

5
RISC-based
Solutions

6
PACSmate
Medical

7
Optional
Peripherals

AUPS Mechanical Drawing (Unit: mm)

AUPS-A10/20

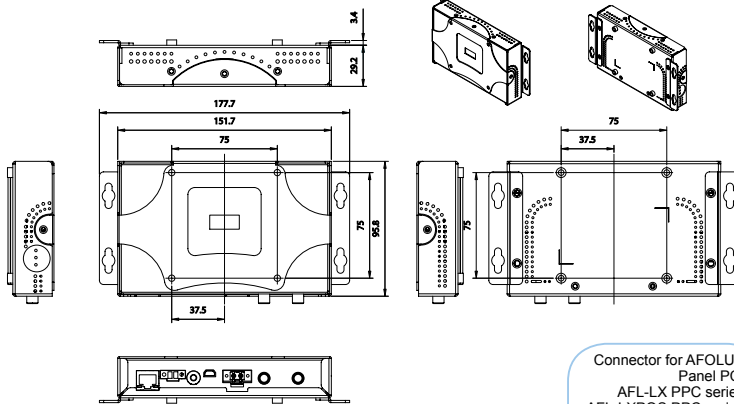

Connector for AFOLUX Panel PC:
 AFL-LX PPC series
 AFL-LXPOS PPC series
 AFL-CX2 PPC series
 AFL-9103 PPC series
 AFL-N270 PPC series

AUPS-B10/20

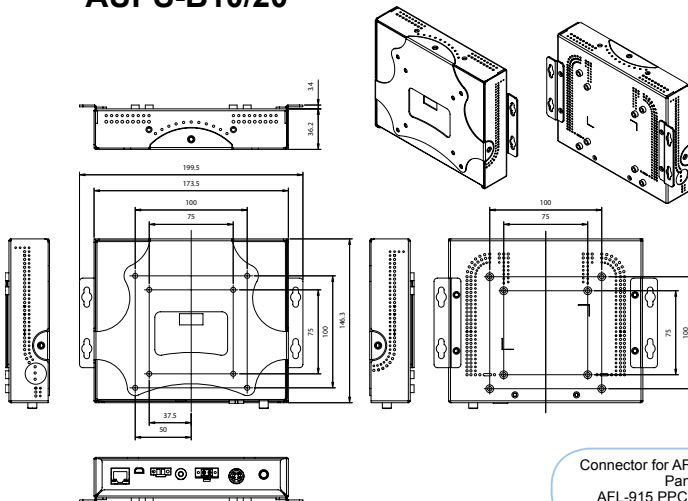

Connector for AFOLUX Panel PC:
 AFL-915 PPC series
 AFL-965 PPC series

Connector for AFOLUX Panel PC:
 AFL-LX PPC series
 AFL-LXPOS PPC series
 AFL-CX2 PPC series
 AFL-9103 PPC series
 AFL-N270 PPC series

DC Power Cable (DC plug to DC plug) with lock
 32000-115300-RS



Remote Switch Cable
 32000-115600-RS



USB Connection Cable
 32000-115500-RS



DC Power Cable (DC plug to DC plug)without lock
 32000-120400-RS



DC Power Cable (DC plug to DC plug) with lock
 32000-115300-RS



Remote Switch Cable
 32000-115600-RS

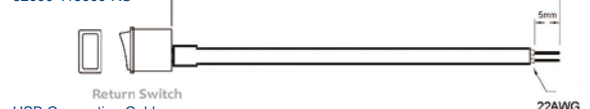

USB Connection Cable
 32000-115500-RS

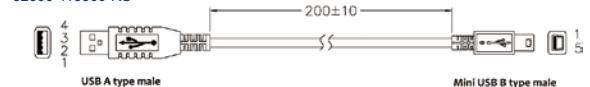

DC Power Cable (DC plug to mini DIN)
 32000-115400-RS

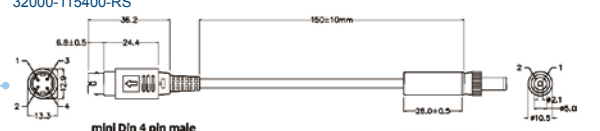

DC Power Cable (DC plug to DC plug)without lock
 32000-120400-RS



Ordering Information

Part No.	Description
AUPS-A10-R10	VESA 75, DC 12V input, 12V output 60W UPS module with 3800mAh, 2S2P Li-Ion battery
AUPS-A20-R10	VESA 75, DC 9~36V input, 12V output 60W UPS module with 3800mAh, 2S2P Li-Ion battery
AUPS-B10-R10	VESA 100, DC 12V input, 12V output 100W UPS module with 3800mAh, 2S4P Li-Ion battery
AUPS-B20-R10	VESA 100, DC 9~36V input, 12V output 100W UPS module with 3800mAh, 2S4P Li-Ion battery
BAT-LI-2S2P3800 (AUPS-A10/20)	Smart battery ;TE9IC032K1002 ;Lithium ion battery (S2P); 7.4V;3800mAh;RoHS
BAT-LI-4S2P3800 (AUPS-B10/20)	Smart battery ;TE9IC042K1002 ;Lithium ion battery (4S2P); 14.8V;3800mAh;RoHS

Packing List

Item	DC power cable, 150mm. Male 4-pin mini-DIN to DC plug 5.0x2.1 (AUPS-B10/B20 only)	DC power cable, 150mm, DC plug 5.5x2.1 to DC plug 5.0x2.5 without lock	DC power cable, 150mm, DC plug 5.5x2.1 to DC plug 5.0x2.5 with lock	USB cable, 200mm, USB type A male to mini USB	Remote switch cable, 1200mm	Screws kit	Utility CD (including utility software and user's guide)
Part Number	32000-115400-RS	32000-120400-RS	32000-115300-RS	32000-115500-RS	32000-115600-RS	44013-030041-RS	7B000-000087-RS
Q'ty	1	1	1	1	1	1	1

1 Automation Panel Solutions
 2 All-in-One Touch POS
 3 Digital Signage
 4 Video Wall Controller
 5 RISC-based Solutions
 6 PACSmate Medical
 7 Optional Peripherals