

IEI PCI Riser Card

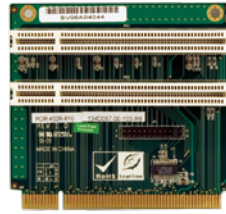

PCIR-K01R-R10

1-slot PCI riser card
89.1 x 62.8 x 16 mm
PCI 2.2 standard with 32-bit 5V support



PCIR-K02R-R10

2-slot PCI riser card
89.1 x 83.1 x 16 mm
PCI 2.2 standard with 32-bit 5V support



PCIR-K03R-R10

3-slot PCI riser card
89.1 x 103.4 x 16 mm
PCI 2.2 standard with 32-bit 5V support

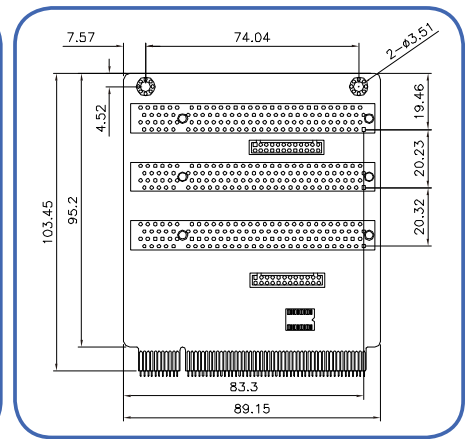
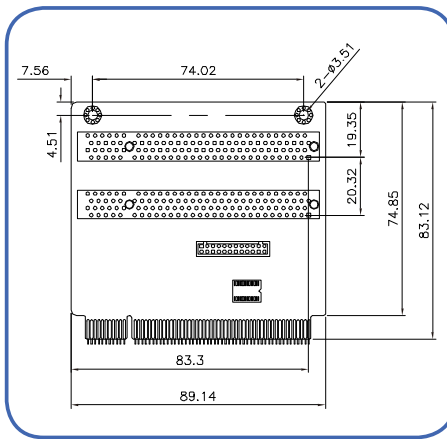
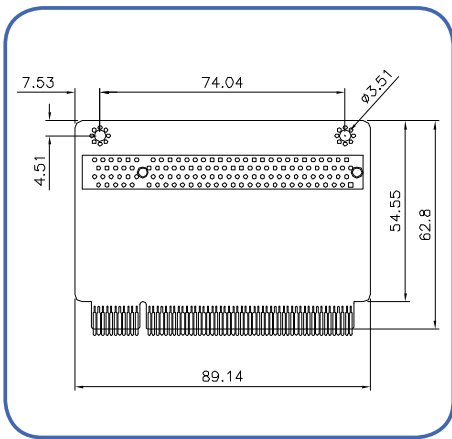

PCI riser card by cable



PCIR-CB01R-R10

1-slot PCI riser card 18.5 x 111.9 mm
Packing list:
2 x PCI riser card connection cable
1 x 1-Slot PCI riser card
1 x Golden finger connection board
1 x QIG

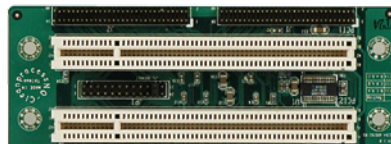

PCIR-CB02R-R10

2-slot PCI riser card 38.9 x 111.9 mm
Packing list:
2 x PCI riser card connection cable
1 x 2-Slot PCI riser card
1 x Golden finger connection board
1 x QIG

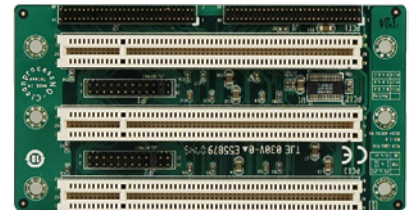

PCIR-CB03R-R10

3-slot PCI riser card 59.2 x 111.9 mm
Packing list:
2 x PCI riser card connection cable
1 x 3-Slot PCI riser card
1 x Golden finger connection board
1 x QIG

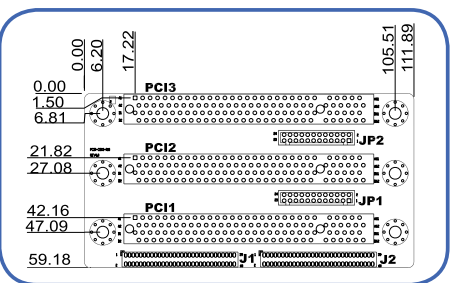
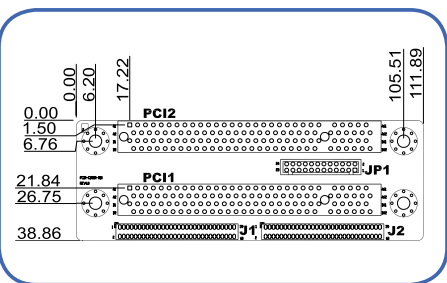
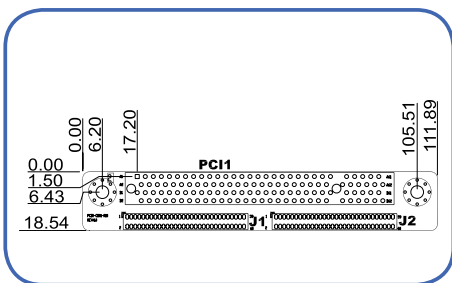

Compliant motherboard

PCIR-CB01R PCIR-K01R	PCIR-CB02R PCIR-K02R	PCIR-CB03R PCIR-K03R
• IMBA/IMB series (Micro ATX/ ATX)	KINO-9652-R11	KINO-9652-R11
• KINO series (Mini-ITX)	KINO-9453-R20	KINO-9453-R20
• NOVA series (5.25" SBC)	KINO-9452-R20	KINO-9452-R20
	NOVA-9452-R20	NOVA-9452-R20

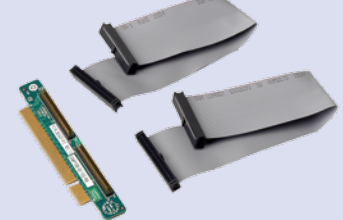
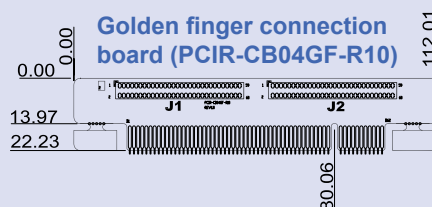

1
Industrial Computing Solutions

2
Embedded Computing Solutions

3
Industrial Data Collector and Controller

4
Video Capture Solutions

5
I/O Communication Solutions

6
Panel Solutions

7
ORing Network Communication

8
Power Supply/ Peripherals