

IEI PCI Riser Card

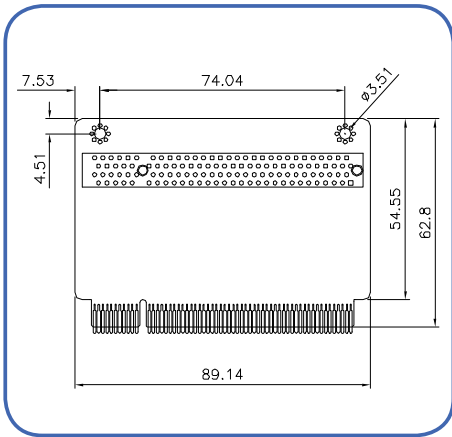

PCIR-K01R-R10

1-slot PCI Riser Card
89.1x62.8x16 mm
PCI 2.2 standard with 32-bit 5V support



PCIR-K02R-R10

2-slot PCI Riser Card
89.1x83.1x16 mm
PCI 2.2 standard with 32-bit 5V support

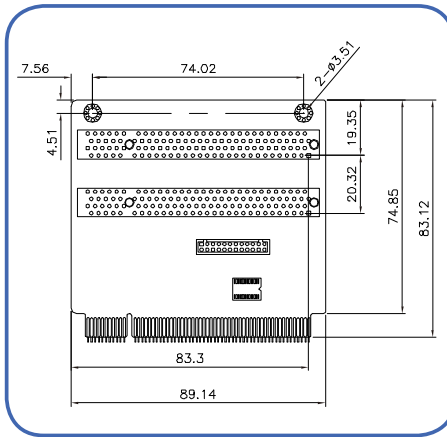

PCIR-K03R-R10

3-slot PCI Riser Card
89.1x103.4x16 mm
PCI 2.2 standard with 32-bit 5V support

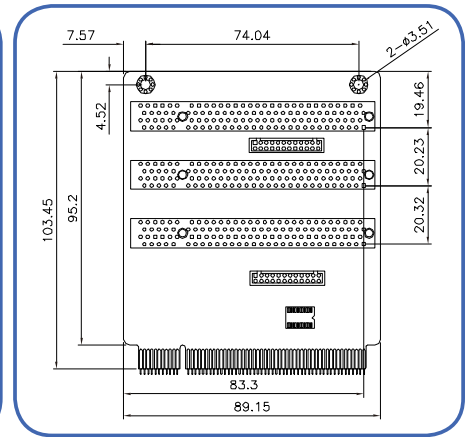

PCI riser card by cable



PCIR-CB01R-R10

1-slot PCI Riser card 18.5x111.9 mm
Packing list:
2 x PCI riser card connection cable
1 x 1-Slot PCI Riser card
1 x Golden finger connection board
1 x QIG

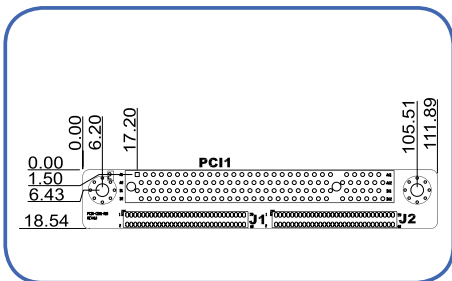

PCIR-CB02R-R10

2-slot PCI Riser card 38.9x111.9mm
Packing list:
2 x PCI riser card connection cable
1 x 2-Slot PCI Riser card
1 x Golden finger connection board
1 x QIG

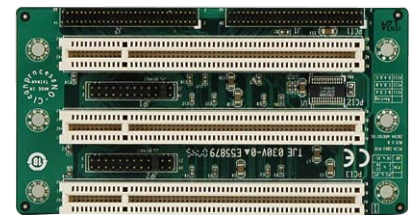
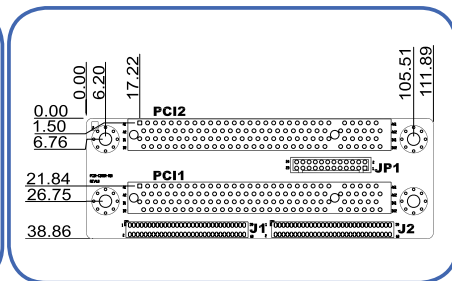

PCIR-CB03R-R10

3-slot PCI Riser card 59.2x111.9 mm
Packing list:
2 x PCI riser card connection cable
1 x 3-Slot PCI Riser card
1 x Golden finger connection board
1 x QIG

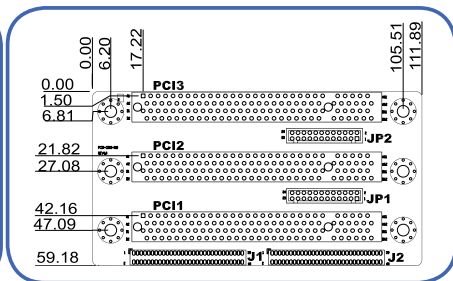

Compliant motherboard

PCIR-CB01R PCIR-K01R	PCIR-CB02R PCIR-K02R	PCIR-CB03R PCIR-K03R
• IMBA/IMB series (Micro ATX/ ATX)	KINO-9652-R11	KINO-9652-R11
• KINO series (Mini-ITX)	KINO-9453-R20	KINO-9453-R20
• NOVA series (5.25" SBC)	KINO-9452-R20	KINO-9452-R20
	NOVA-9452-R20	NOVA-9452-R20

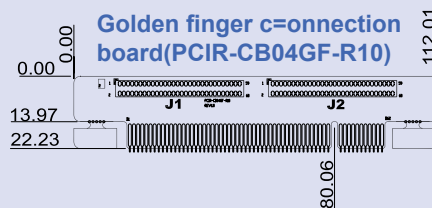

1 Industrial Computing Solutions

2 Embedded Computing Solutions

3 RISC-Based Embedded Solutions

4 Industrial Data Collector/ Server Solutions

5 Video Capture Solutions

6 I/O Communication Solutions

7 Panel Solutions

8 Power Supply/ Network Communication/ Peripherals