

**Industrial Aluminum PPC-27 Series**

**PPC-2710GS/LX-800**

**AMD Geode LX800 500MHz Processor with 10.4" TFT LCD and Touchscreen**

**PPC-2712GS/LX-800**

**AMD Geode LX800 500MHz Processor with 12.1" TFT LCD and Touchscreen**



**Fanless**

**Features**

1. 10.4" TFT SVGA LCD / 12.1" TFT XGA LCD
2. Fanless cooling system
3. 500 MHz AMD Geode™ LX 800 processor
4. Supports 1 GB (max.) 333/444 MHz DDR SO-DIMM
5. Dual 10/100Mbps Ethernet
6. Fanless and ultra-low power consumption
7. Optional 802.11 b/g wireless LAN module
8. One CompactFlash® Type II socket
9. IP 65 compliant aluminum front panel



**Specifications**

		PPC-2710GS/LX-800	PPC-2712GS/LX-800
Display	LCD Size	10.4"	12.1"
	Max Resolution	800(W) x 600(H)	1024(W) x 768(H)
	Brightness (cd/m2)	400	450
	Contrast Ratio	400:1	700:1
	LCD Color	262K	262K
	Pixel Pitch (mm)	0.264(H) x 0.264(V)	0.240(H) x 0.240(V)
	Viewing Angle (V-H)	100/120	160/160
	Backlight MTBF (hrs)	50,000	
Motherboard	SBC Model	AFLMB-LX-800	
	CPU	AMD Geode LX800 500MHz processor	
	Chipset	AMD Geode LX800 + AMD CS5536	
	RAM	Supports one 333/400MHz DDR SO-DIMM(1GB Max.)	
I/O Ports and Switches	2 x RS232 COM Port		2 x RS232 COM Port
	2 x RJ-45 for 10/100Mbps LAN		2 x RJ-45 for 10/100Mbps LAN
	2 x USB 2.0		4 x USB 2.0
	1 x VGA Port		1 x VGA Port
	1 x Audio (Line-out)		1 x Audio (Line-out)
	1 x PS/2 (KB/MS)		1 x PS/2 (KB/MS)
	1 x 12VDC input Power Jack		1 x 12VDC input Power Jack
	1 x Power Switch		1 x Power Switch
	1 x Reset Button		1 x Reset Button
	Driver Bay	HDD Driver Bay	1 x 2.5" SATA/IDE HDD Bay
SSD		CF Type II	
CD-ROM Driver Bay		N/A	
Extension Slot	1 x Wireless LAN 802.11 b/g Module (internal Mini PCI interface)		
Physical	Construction Front Panel	Aluminum	
	Construction Chassis	Heavy-duty Steel	
	Mounting	Panel, Wall, Rack, Stand and Arm VESA 100mm x 100mm	
	Front Panel Color	Silver (Pantone 8001C)	
	Dimension (WxHxD) (mm)	311.5 x 242 x 58	340 x 260 x 66
	Net Gross Weight	2.8 Kg / 5.5 Kg	2.8 Kg / 5.7 Kg
Environment	Operation Temperature (°C)	-10°C ~50°C	
	Storage Temperature (°C)	-20°C ~60°C	
	Vibration	5~17Hz, 0.1" double amplitude displacement 17~640Hz, 1.5G acceleration peak to peak	
	Shoock	10G acceleration part to part (11ms)	
Touch Screen	Resistive Type 5-Wire with RS-232 interface		
Power Supply	AC / DC Power Adapter	P/N: 63000-FSP0481AD101C-RS 48W Power Adapter Input: 90VAC~264VAC, 50/60Hz Output: 12VDC	
Front Panel Protection	IP65 Compliant		
Certificate	Meets CE, FCC		

1  
Automation

2  
Point of Service

3  
Digital Signage

4  
RISC-based Solutions

5  
Medical Solutions

**Dimensions** (Unit: mm)

▼ **PPC-2710GS**

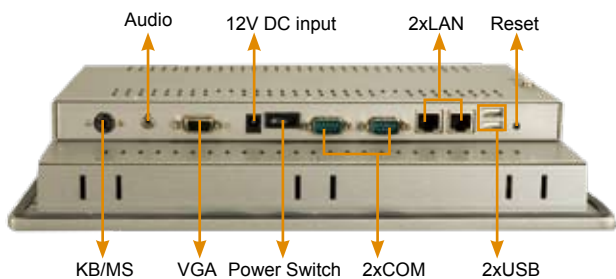

▼ **PPC-2712GS**

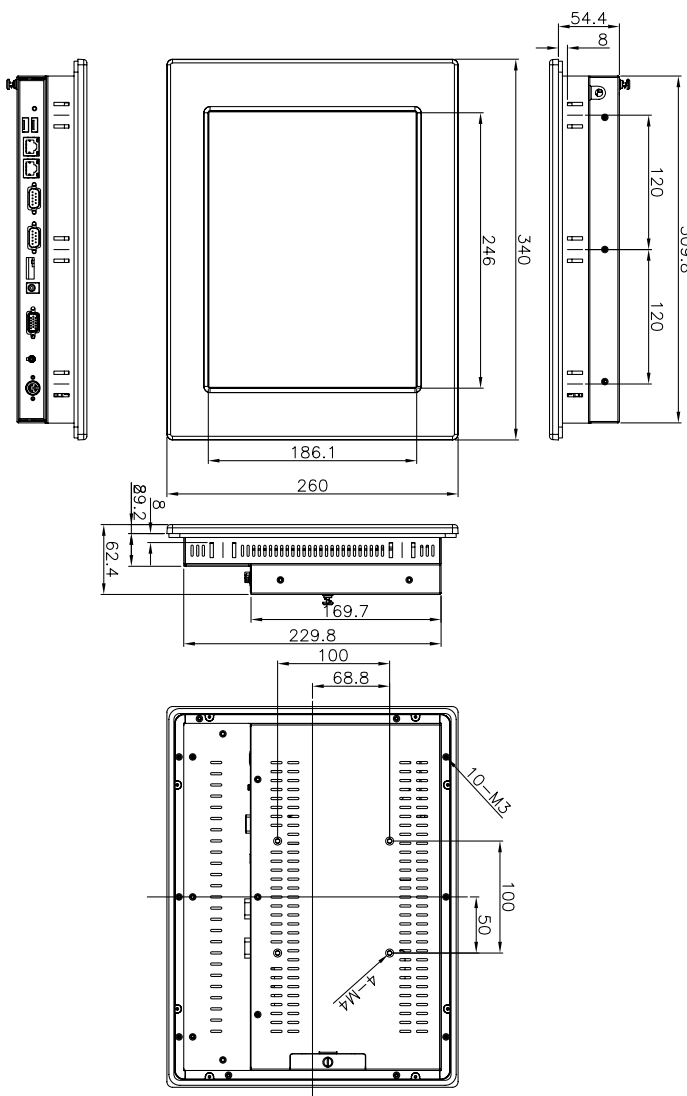
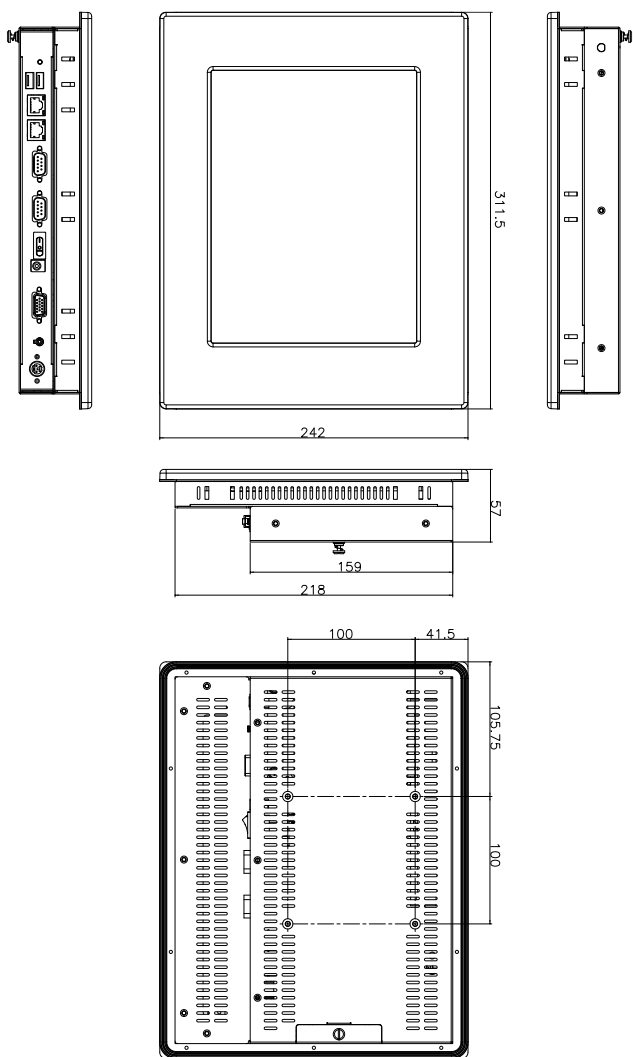
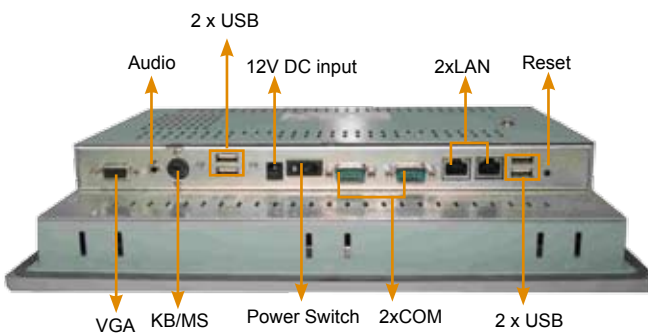

**IQ Mount Supporting List**

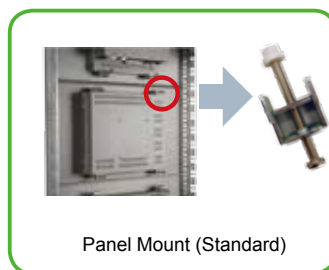
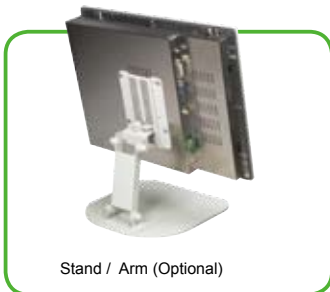

## Optional 802.11 b/g Wireless LAN Module

The PPC-2710G and PPC-2712G equip with a wireless module that make larger bundles of data be transmitted at high speed and in real-time. The application of wireless LAN facilitates its use in large warehouses and at greater distances.

### Long distance communication



## Fanless System

The PPC-2710G and PPC-2712G are designed with an AMD LX-800 platform. The AMD Geode™ LX 800 generates less heat than other processors but maintains an above-average performance enabling a fanless design. A fanless design reduces the failure caused by fans and extends the operation life of the device.

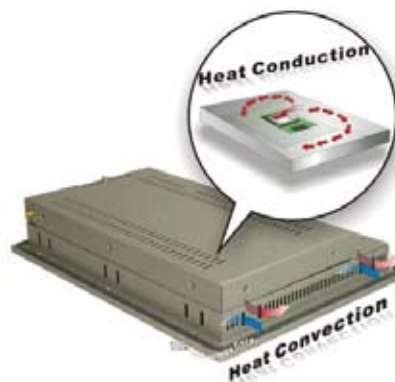

## Packing List

Description	Part Number	Amount
Screw Kit	19600-000207-RS	1
Jumper Pack	33100-000033-RS	1
Power Cord	32000-000002-RS	1
Power Adapter	63000-FSP0481AD101C-RS (PPC-2710GS/LX) 63000-FSP0601AD101C712-RS (PPC-2712GS/LX)	1
PS/2 Cable	32000-000138-RS	1
Panel Mounting Kits	PK-104M (PPC-2710GS/LX) PK-121M (PPC-2712GS/LX)	1
Wall Mounting Kit	WK-190MS-R10	1
Touch Screen Driver CD / Touch Pen		1
User Manual & Driver CD		1

## Options

	PPC-2710GHS/LX	PPC-2712GS/LX
Rack mount kits	RK-104MS-R10	RK-121MS-R10
LCD Monitor Arm	ARM-11-RS	ARM-11-RS
LCD Monitor Stand Din Mounting Kits	STAND-100-RS/STAND-150-RS	STAND-100-RS/STAND-150-RS

## Ordering Information

10.4" TFT LCD	PPC-2710GHS/AFLMB-LX-800/T-R/256MB	10.4" 400 cd/m <sup>2</sup> SVGA TFT Panel PC with AFLMB-LX-800, Silver Color & Touch Screen, 256MB RAM, RoHS
	PPC-2710GHS/AFLMB-LX-800/WT-R/256MB	10.4" 400 cd/m <sup>2</sup> SVGA TFT Panel PC with AFLMB-LX-800, Silver Color, 802.11 b/g wireless module & Touch Screen, 256MB RAM, RoHS
12.1" TFT LCD	PPC-2712GS/AFLMB-LX-800/T-R/256MB	12.1" 450 cd/m <sup>2</sup> XGA TFT Panel PC with AFLMB-LX-800, Silver Color & Touch Screen, 256MB DDR RAM, RoHS
	PPC-2712GS/AFLMB-LX-800/WT-R/256MB	12.1" 450 cd/m <sup>2</sup> XGA TFT Panel PC with AFLMB-LX-800, Silver Color, 802.11 b/g Wireless module and Touch Screen, 256MB DDR RAM, RoHS

1

Automation

2

Point of Service

3

Digital Signage

4

RISC-based Solutions

5

Medical Solutions